



MICRO 8

**MINIATURIZED DIGITAL MICROWAVE BARRIER
200 m RANGE
WITH PLANAR ANTENNA**

Installation and user manual



MADE IN ITALY

Index

Introduction and warnings	Page 3
Components	Page 4
Mounting options	Pages from 5 to 9
• Wall installation	5
• Wall installation with MICRO BOX	6
• Pole installation	7
• Pole installation with MICRO BOX	8
• Horizontal and vertical orientation	9
Microwave device	Pages from 10 to 20
• Introduction	10
• Features and non-detection zones	10
• Receiver board (RX)	11
Description of dip switch and terminal board	
• Transmitter board (TX)	12
Description of dip switch and terminal board	
Installation	Pages from 13 to 20
• Alignment procedure	13
• Manual configuration by dip-switch	14
Changing the frequency	
RX module - signal sensitivity setting	
RX module - setting of the signal attenuation time	
TX module - setting of 4dB transmission signal attenuation	
• Control through software (RS485)	16
Description of columns and parameters modification	
Columns READ - WRITE - REAL TIME	
Connection options via RS485-USB adapter	
Warnings	Page 21
Product photos	Page 22
Notes	Page 23

Introduction and warnings

INTRODUCTION

MICRO 8 is the state of the art miniaturized microwave barrier and represents an absolute innovation on the market.

Micro 8 has a diameter of only 8 cm and a very narrow lobe aperture.

The microwave device has a high degree of reliability and consists of a transmitting and a receiving unit.

The technology adopted is the planar of a new generation and military derivation,

with ultra-compact dimensions due to the absence of the cumbersome antenna dish.

The presence of an intruder is detected using a system of high-frequency electromagnetic waves.

MICRO 8 is suitable for industrial, residential, and commercial areas, prisons, military settlements and in general in all applications where it is also necessary to protect large areas.

WARNINGS

- **Use shielded cables.**
- **Power the device using the 13.8 Vdc stabilised voltage only.**
- **The installation should be performed by qualified personnel.**
- **MITECH is not responsible for damages and / or barrier malfunctions caused by incorrect installation and / or improper use.**



Components

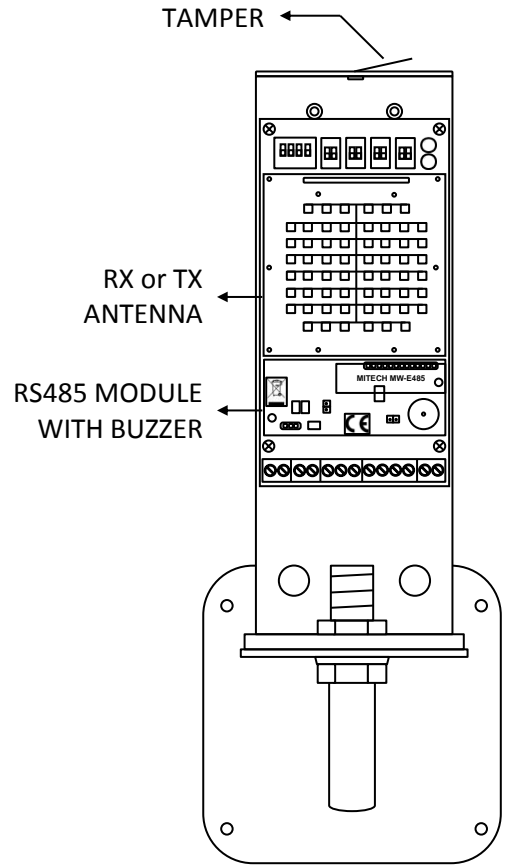
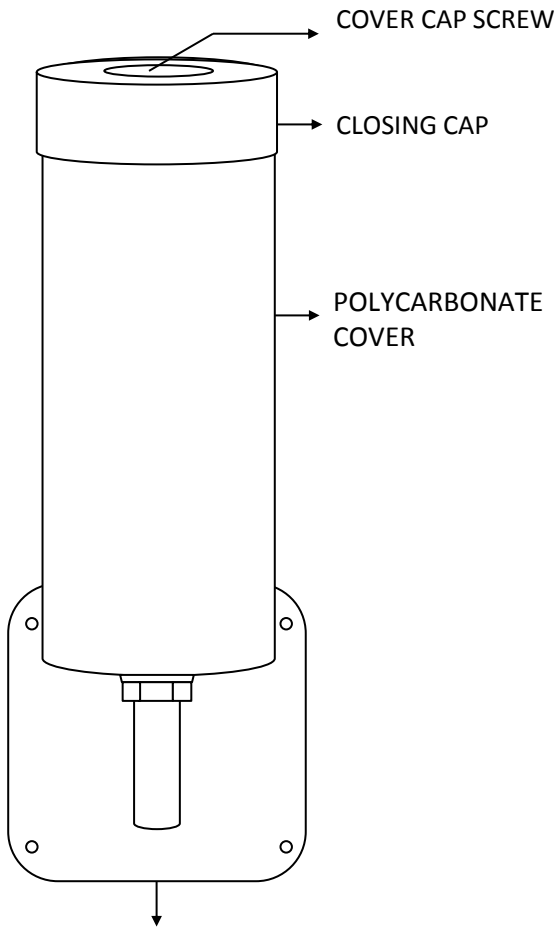

MICRO PL
POLE MOUNTING
BRACKET

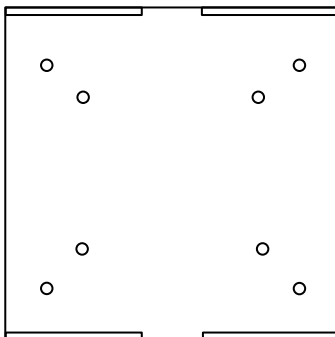

MICRO BOX
BOX FOR WALL OR POLE
MOUNTING

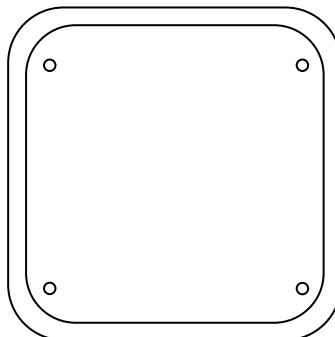





(Dimensions 100x100x50 mm)

CABLE GLAND
TO USE
WITH MICRO BOX



Mounting options

Wall installation

1. Place the main bracket at a height between 80 and 90 cm from the ground, and drill four holes with a 5 mm drill bit (figure 1). Make sure that the wall cable exit hole is aligned with that of the bracket.
2. Fix the bracket using the screws and plugs (figure 2).
3. Screw the flanged M16 nut  and tighten it with a 16 mm wrench (figure 2).
4. Insert the following components (figures 3 and 4):
 - the main structure where the RX or TX antenna is connected
 - the serrated washer 
 - the M16 nut  tightening it with a 16 mm wrench
5. Insert the cables and make the connections (see pages 11 and 12).
Note: the tamper signal can be taken by connecting it directly to the microswitch, or by connecting the microswitch to the TAMPER IN input of the antenna and then picking up the signal from the TAMPER OUT output.
6. Align the antennas (see installation procedure on pages 13 and 14).
7. Insert the following components (figure 5):
 - polycarbonate cover
 - closing cap by tightening it with the M4 screw 
 - Screw cover cap 

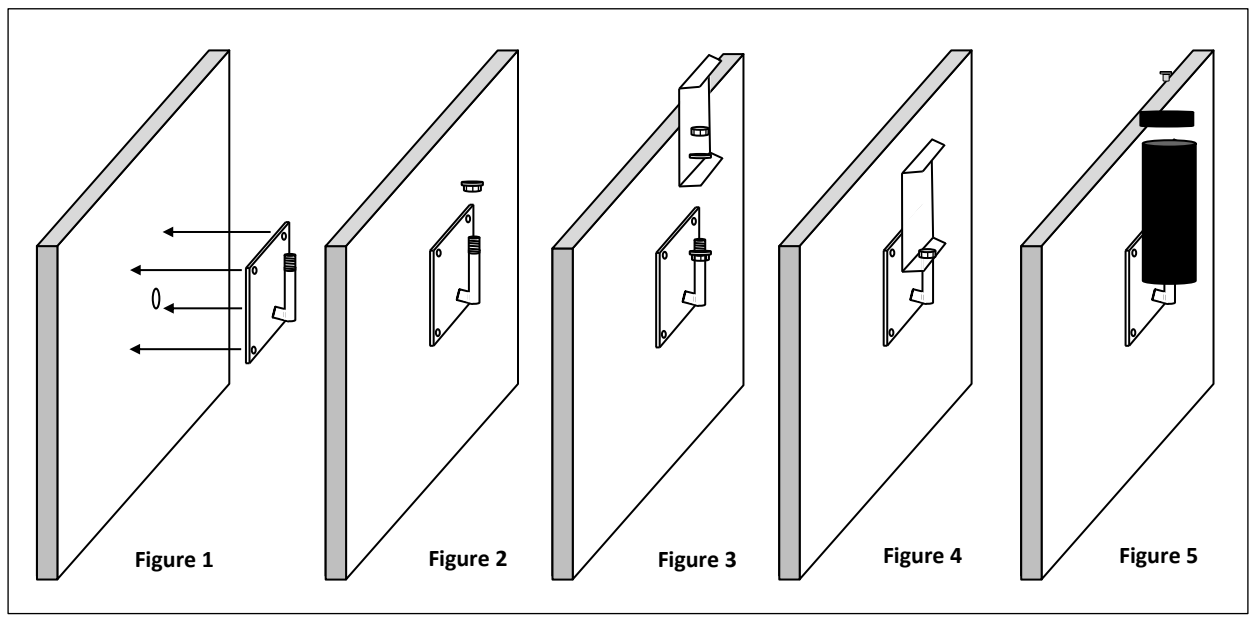



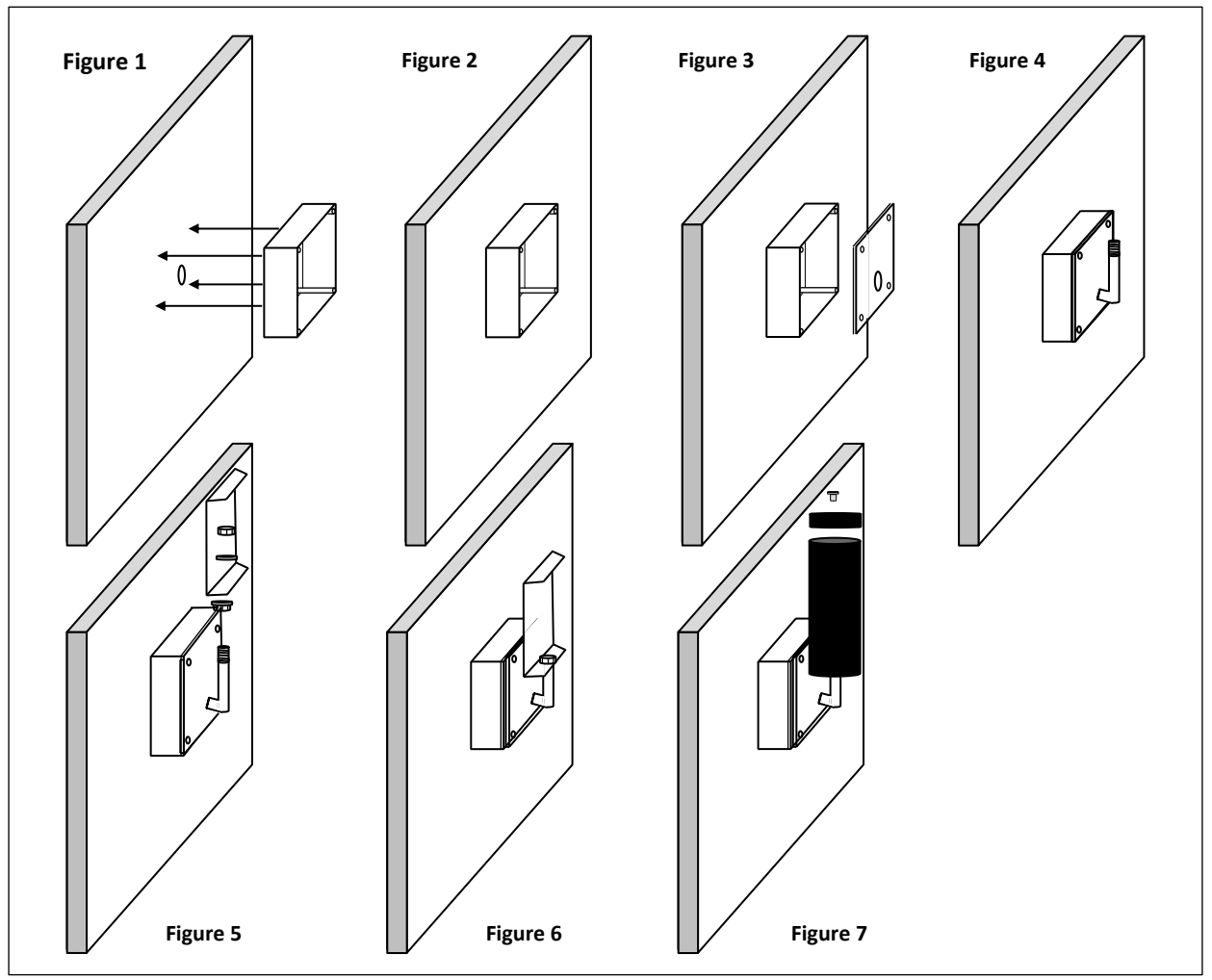

Wall installation with MICRO BOX

1. Position the base of the MICRO BOX on the wall where you want to install the barrier (height between 80 and 90 cm from the ground) and make four holes with a 5 mm tip (figure 1).
2. Fix the base to the wall using the four screws, plugs and washers supplied (figure 2). If the supplied cable gland is not used, make a hole in the base of the MICRO BOX verifying that the hole is in line with that of the wall cable outlet (figure 1). If not, make a hole in one of the four sides of the base and fix the PG8 (figure 2).
3. Drill a hole in the center of the MICRO BOX cover using the template provided (figure 3).
4. Insert the cables into the base and into the MICRO BOX cover, into the main bracket and close using the four supplied screws (figure 4).
5. Follow the procedure already indicated in the pole installation from point 3 (see page 5).



Pole installation

1. Position the main bracket at a height between 80 and 90 cm from the ground and make a hole in the pole, maximum diameter 10/12 mm (figure 1).
2. Position the MICRO PL bracket at the back of the pole and use the four M4x70 screws and the supplied washers to fix the two brackets (figures 1 and 2). Make sure that the pole cable exit hole is aligned with that of the bracket.
3. Screw the flanged M16 nut  and tighten it with a 16 mm wrench (figure 2).
4. Insert the following components (figures 3 and 4):
 - the main structure where the RX or TX antenna is connected
 - the serrated washer 
 - the M16 nut  tightening it with a 16 mm wrench
5. Insert the cables and make the connections (see pages 11 and 12).
Note: the tamper signal can be taken by connecting it directly to the microswitch, or by connecting the microswitch to the TAMPER IN input of the antenna and then picking up the signal from the TAMPER OUT output.
6. Align the antennas (see installation procedure on pages 13 and 14).
7. Insert the following components (figure 5):
 - polycarbonate cover
 - closing cap by tightening it with the M4 screw 
 - Screw cover cap 

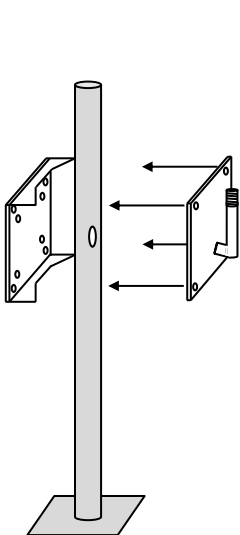

Figure 1

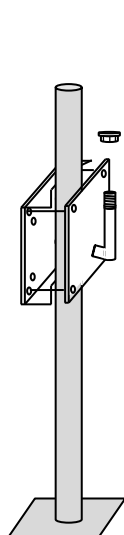

Figure 2

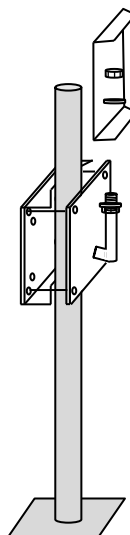

Figure 3

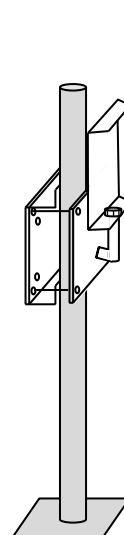

Figure 4

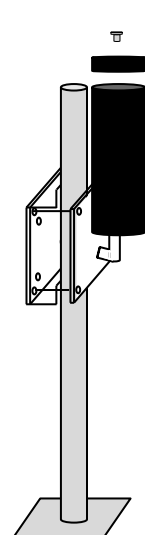

Figure 5

Pole installation with MICRO BOX

1. Make a hole in the pole at a height of 80/90 cm from the ground in case you do not use the cable gland supplied (figure 1), otherwise make a hole in one of the four sides of the base of the MICRO BOX and fix the PG8 (figure 2).
2. Position the MICRO PL bracket at the back of the pole and using the four M4x70 screws and the supplied washers fix the MICRO PL bracket to the base of the MICRO BOX (figures 3 and 4).
3. Drill a hole in the center of the MICRO BOX cover using the template provided (figure 5).
4. Insert the cables into the base and into the MICRO BOX cover, into the main bracket and close using the four supplied screws (figure 6).
5. Follow the procedure already indicated in the pole installation from point 3 (see page 7).

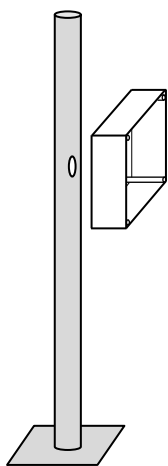

Figure 1

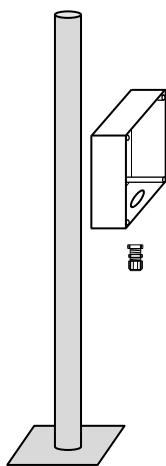

Figure 2

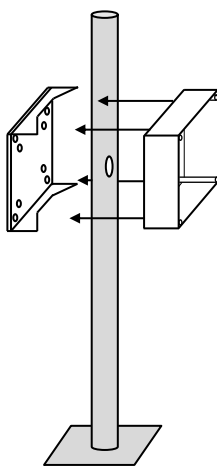

Figure 3

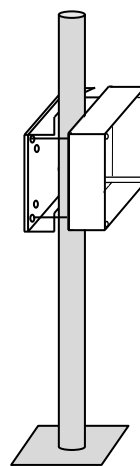

Figure 4

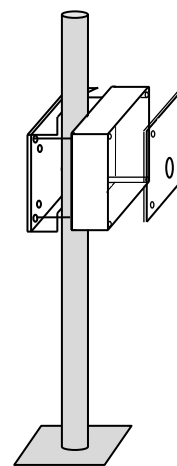

Figure 5

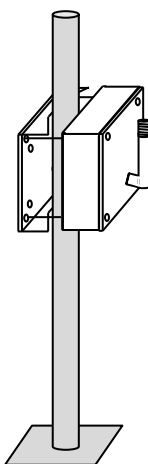

Figure 6

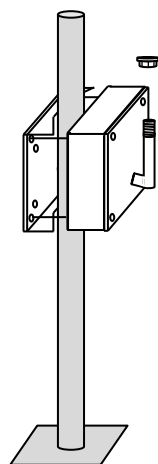

Figure 7

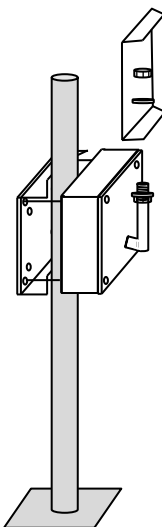

Figure 8

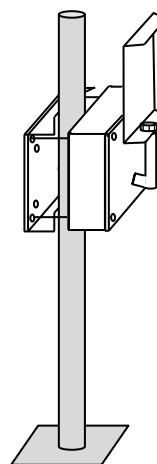

Figure 9

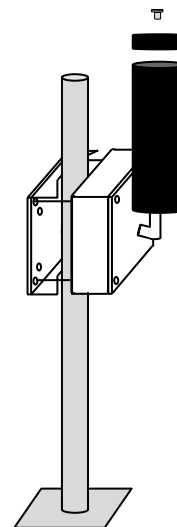
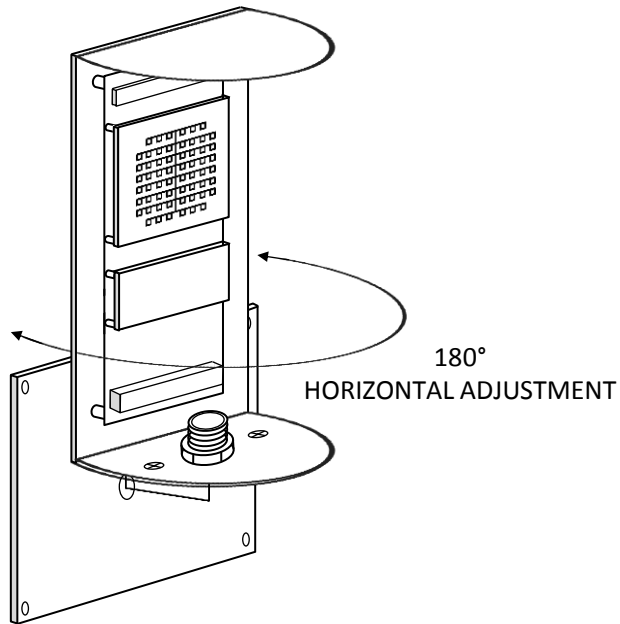

Figure 10

Horizontal and vertical adjustment

Horizontal adjustment



Vertical adjustment

It is possible to orient the antenna vertically by adjusting the four fixing screws up to a maximum of 5°.

FRONT VIEW

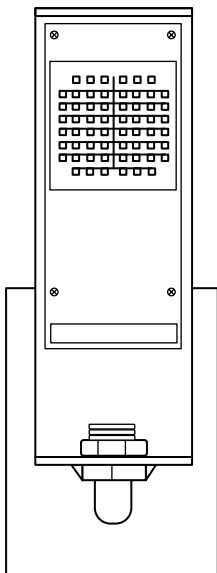

SIDE VIEW 1

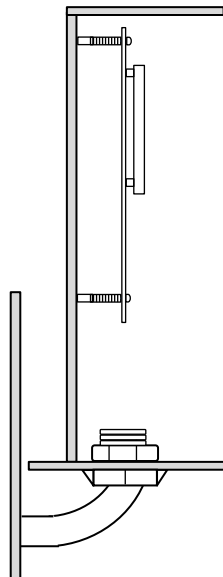

LATERAL VIEW 2
5° DOWNWARD
ADJUSTMENT

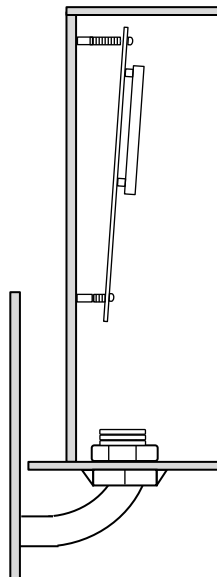

LATERAL VIEW 3
5° UPWARD
ADJUSTMENT

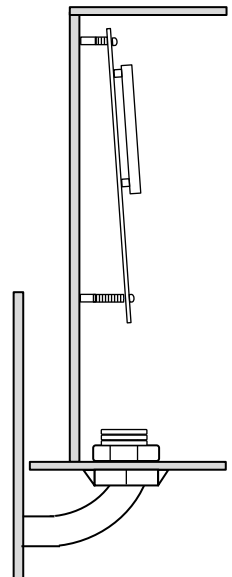

Microwave device

The microwave device consists of two TX and RX units to be positioned at opposite ends of the protected area. The TX unit emits electromagnetic waves in the direction of the RX unit that receives them, processes them and translates them into an electrical signal that is analyzed. The intruder who crosses the detection area (ZR) causes a change in the signal. The intensity and type of signal depend on the following factors, size and mass of the intruder who crosses the ZR, speed and time of crossing the ZR, conformation and soil conditions

Technical features

Maximum range	200 m
Detection speed	from 0,1 to 10,0 m/s
Power supply	from 12 to 36 Vdc
Consumption	module TX 70 mA - module RX 110 mA
Recovery time after alarm notification	10 s
Duration of the report	5 s
Operating frequency	from 24.000 to 24.250 GHz (K band)
Selectable frequencies	By dip-switch: 16 - by software: 250
Maximum lobe height	2,5 m
Maximum lobe aperture	50 m range: 0,6 m at 25 m 100 m range: 1,2 m at 50 m 200 m range: 2,4 m at 100 m
Installation height	From 80 to 90 cm from the ground
Standard compliance	EN 50131-1 and CEI 79-3
ROhs compliance	2011/65/UE
Protection class	IP 65
Warranty	3 years

Non-detection zones

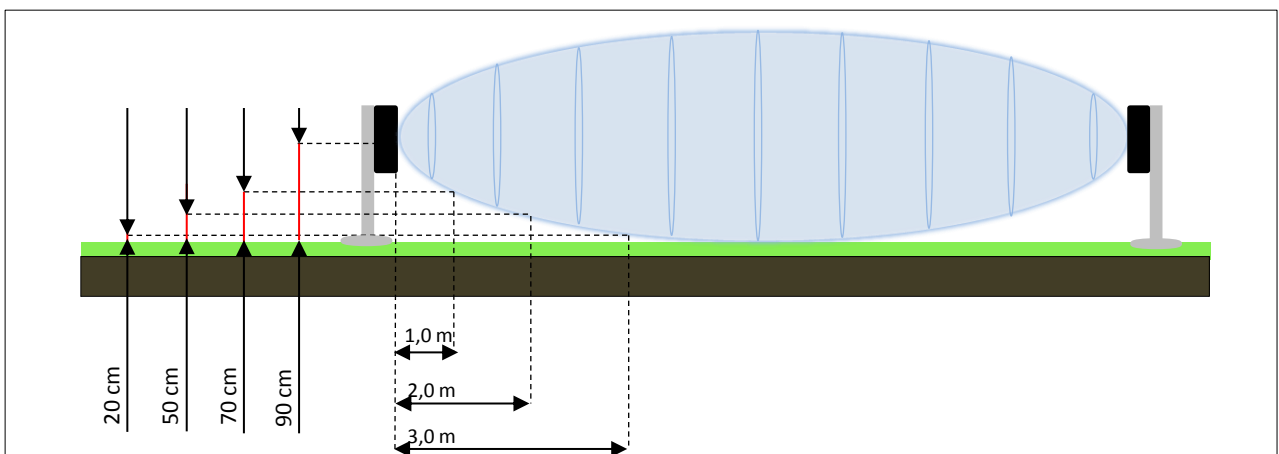

Receiver board (RX)

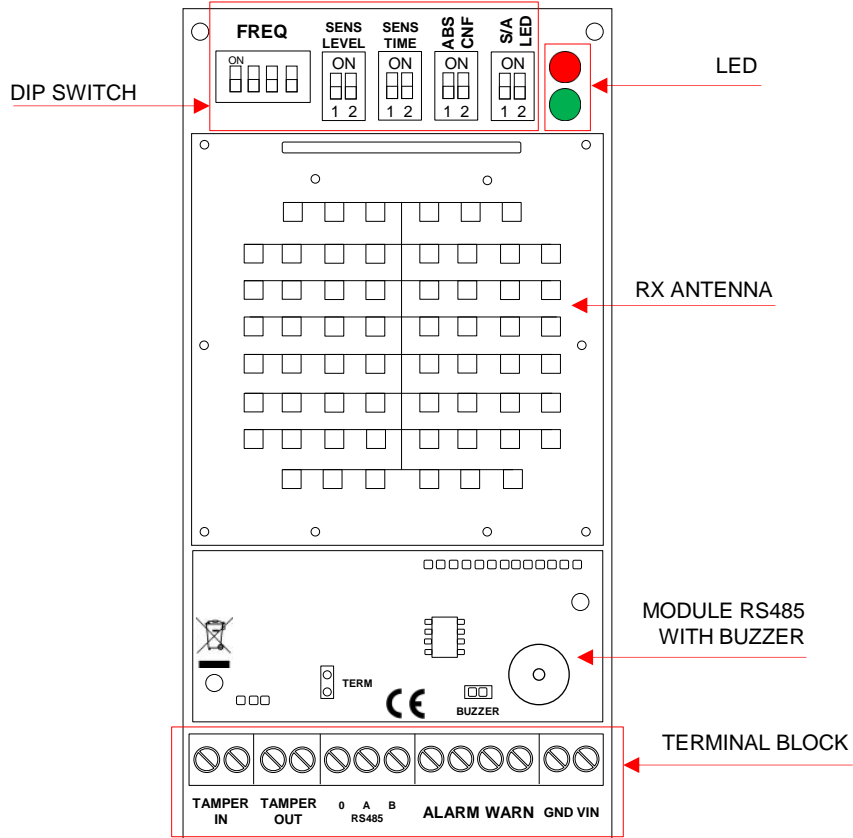

Dip-switch description :

FREQ: frequency setting

SENS LEVEL: signal attenuation level setting

SENS TIME: signal attenuation duration setting

ABS: detection mode setting (PARAMETER NOT TO CHANGE)

CNF: activation of configuration mode

S/A: activation of the RS485 module for software management

LED: led activation

Terminal board description:

TAMPER IN: tamper input

TAMPER OUT: tamper output

0 A B: RS485

ALARM: alarm output

WARN: anti-masking output

GND: 0 V

VIN: +12 Vdc

Transmitter board (TX)

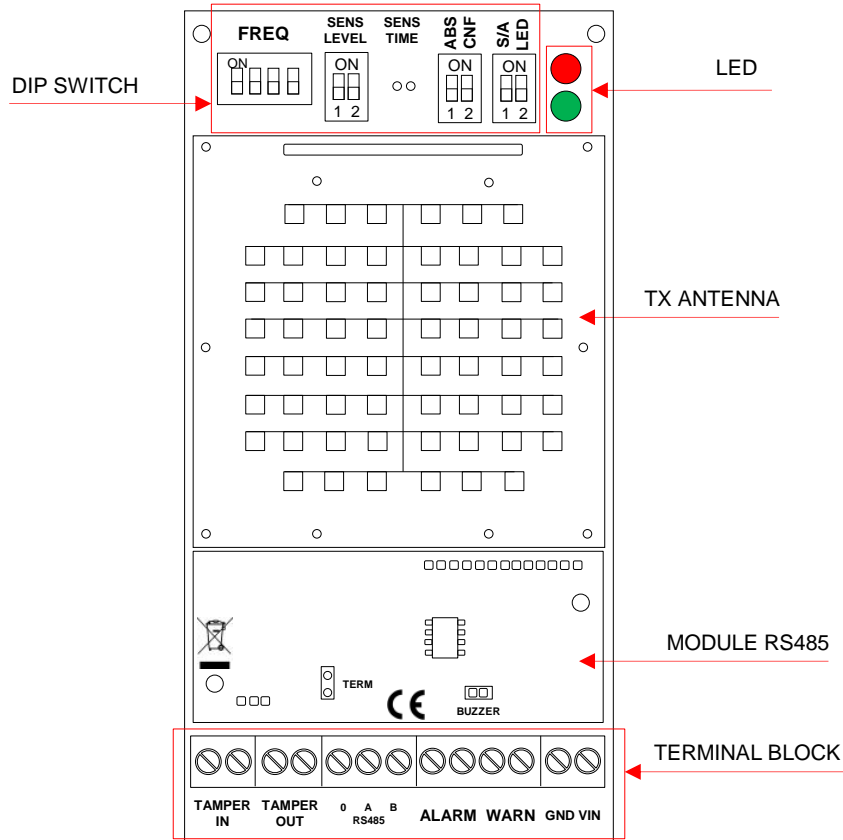

Dip-switch description:

FREQ: frequency setting

SENS LEVEL: attenuation of the 4 dB transmission level

ABS: not used

CNF: activation of configuration mode

S/A: activation of the RS485 module for software management

LED: led activation

Terminal board description:

TAMPER IN: tamper input

TAMPER OUT: tamper output

0 A B: RS485

ALARM: fault output

WARN: not used

GND: 0 V

VIN: +12 Vdc

Installation

Introduction

The MITECH antennas can be managed manually via the dip-switches on both the RX and TX modules or by using the MITECH Radar Barrier configuration proprietary program.

IMPORTANT: the modules always keep the last saved configuration in memory even in the event of a power failure.

Alignment procedure

As standard the dip-switches on the RX and TX modules are programmed as follows:

RX MODULE											
FREQ				SENS LEVEL		SENS TIME		ABS	CNF	S/A	LED
OFF	OFF	OFF	OFF	OFF	OFF	OFF	OFF	OFF	OFF	ON	OFF

TX MODULE									
FREQ				SENS LEVEL		ABS	CNF	S/A	LED
OFF	OFF	OFF	OFF	OFF	OFF	OFF	OFF	ON	OFF

1. Position the CNF dip-switch of the RX and TX module in ON mode. In this condition the led will start to flash for a few seconds, confirming the input in configuration mode (on the TX module the red led will remain lit, see paragraph TX Module - setting the transmission level attenuation by 4dB on page ...).
2. Defining the working frequency by programming the FREQ dip-switches of both modules, **the programming of the dip-switches of the RX module must be the same as that of the TX module.** If you do not want to change the frequency go directly to point 3.
3. **Orient the RX module towards the TX module in order to obtain the greater intensity of the green RX led and the greater speed of the buzzer signal (to activate the buzzer act on the BUZZER jumper). The turning on of the red led and the lower speed of the buzzer signal, mean that you are moving away from the optimal position.**
If necessary also act on the orientation of the TX module.

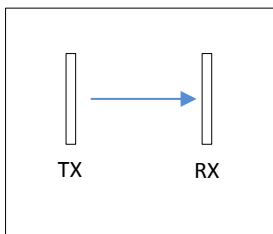

YES

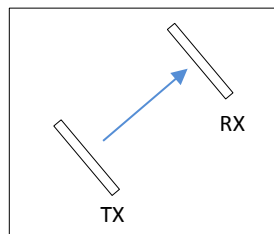

YES

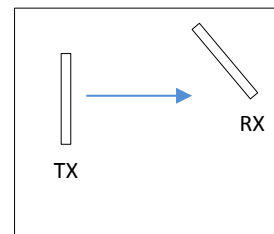

NO

4. At the end of the alignment if you want to keep the led on, program the led dip-switches in ON mode on both modules.
5. If you do not want to change other parameters and then exit the configuration mode, program the CNF dip-switch in OFF mode on both modules, avoiding interrupting the signal and moving the antennas.

Manual control

Changing the frequency

By using the FREQ dip-switches on the RX and TX antennas, it is possible to change the frequency. Frequency is set to 1 from production.

Procedure:

1. Enter the configuration mode (CNF in ON) and wait for the led to stop flashing.
2. Program the 4 dip-switches following the combinations indicated in the following table:

		NUMBER OF FREQUENCY (1 TO 16)															
		1	2	3	4	5	6	7	8	9	10	11	12	13	14	15	16
DIP	1	OFF	OFF	OFF	OFF	OFF	OFF	OFF	OFF	OFF	ON	ON	ON	ON	ON	ON	ON
	2	OFF	ON	ON	ON	OFF	OFF	ON	OFF	ON	OFF	OFF	OFF	ON	ON	OFF	ON
	3	OFF	OFF	ON	ON	ON	OFF	OFF	ON	ON	ON	OFF	OFF	OFF	ON	ON	OFF
	4	OFF	OFF	OFF	ON	ON	ON	ON	OFF	ON	ON	ON	OFF	OFF	OFF	OFF	ON

2. Proceed in the same way also on the TX antenna.
Important: the programming of the dip-switches of the RX and TX units must be the same.
4. Exit the configuration mode by programming the CNF dip-switch in OFF mode, avoiding interrupting the signal and moving the antenna.

RX board - signal attenuation level setting

By using the SENS LEVEL dip-switches on the RX board , you can set the signal attenuation level.

Procedure:

1. Enter the configuration mode (CNF in ON) and wait for the led to stop flashing.
2. Program the two dip-switches following the combinations indicated in the following table:

DIP 1	DIP 2	
OFF	OFF	Minimal Sensitivity (-5db)
ON	OFF	(-3,8 db)
OFF	ON	(-2,5 db)
ON	ON	Maximum Sensitivity (-1,5db)

3. Exit the configuration mode by programming the CNF dip-switch in OFF mode, avoiding interrupting the signal and moving the antenna.

RX board - duration setting of signal attenuation

By using the SENS TIME dip-switches on the RX board , it is possible to set the duration of the signal attenuation.

Procedure:

1. Enter the configuration mode (CNF in ON) and wait for the led to stop flashing.
2. Program the two dip-switches following the combinations indicated in the following table:

DIP 1	DIP 2	
OFF	OFF	50 mS
ON	OFF	150 mS
OFF	ON	250 mS
ON	ON	350 mS

3. Exit the configuration mode by programming the CNF dip-switch in OFF mode, avoiding interrupting the signal and moving the antenna.

TX board - 4dB transmission level attenuation setting

By using the SENS LEVEL dip-switches on the TX board , the signal transmission level can be attenuated by 4 dB.

Procedure:

1. Enter the configuration mode (CNF in ON) and wait for the led to stop flashing.
2. Program the two dip-switches in ON mode (the red led will switch off).
3. Exit the configuration mode by programming the CNF dip-switch in OFF mode, avoiding interrupting the signal and moving the antenna.

IMPORTANT

**It is only possible to enter the configuration mode once to program the dip-switches.
In manual control mode it is not possible to make changes using the software.**

MIRS485 module - MITECH radar barrier configuration program start

The MITECH Radar Barrier Configuration program allows, via the RS485 serial connection, the maximum and simultaneous management of 16 pairs of antennas, using only one COM port. In case it is necessary to manage more than 16 pairs of antennas, more COM ports must be used.

Procedure:

1. Program the **S/A** dip-switches of the RX and TX modules in OFF mode.
2. **IMPORTANT: the CNF dip-switches of both modules must be programmed in OFF mode.** Connect the antennas (see Connection options - RS485-USB adapter).
3. Select the MITECH radar barrier configuration program  and wait a few seconds.
4. - Select Com Ports and select the serial port on which the RS485 adapter is connected.
- Select the communication speed according to the converter model used (standard 19200 bps).
- Select the Open Port command, wait a few seconds and then the SCAN key.
After about 16 seconds all the antennas connected to the serial port will be displayed (see Figure 1, example of a pair of antennas connected to COM7).

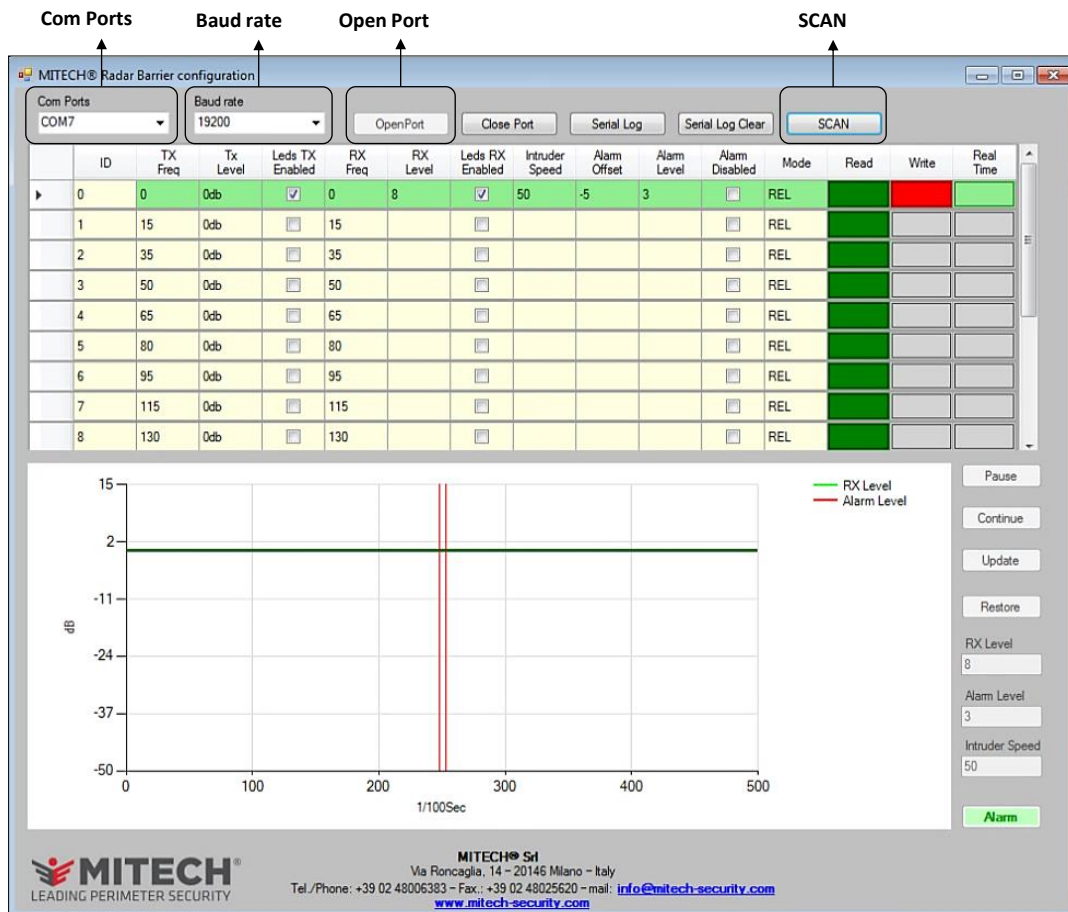

Figure 1

Description of columns and modification of parameters

ID	TX Freq	Tx Level	Leds TX Enabled	RX Freq	RX Level	Leds RX Enabled	Intruder Speed	Alarm Offset	Alarm Level	Alarm Disabled	Mode	Read	Write	Real Time
0	0	0db	<input checked="" type="checkbox"/>	0	8	<input checked="" type="checkbox"/>	50	-5	3	<input type="checkbox"/>	REL			
1	15	0db	<input type="checkbox"/>	15		<input type="checkbox"/>				<input type="checkbox"/>	REL			
2	35	0db	<input type="checkbox"/>	35		<input type="checkbox"/>				<input type="checkbox"/>	REL			

COLUMN ID

Displays the 485 serial addresses that can be controlled from a single COM.
The values entered in this column cannot be changed.

TX AND RX FREQ COLUMN

Displaying the frequency of the TX antenna and the RX antenna (range from 0 to 249 Hz) for each connected module, 16 frequencies are set as standard.

For correct operation, the two TX and RX antennas must have the same frequency.

The program updates the values even if one of the two frequencies is changed. For example, by changing only the freq. TX, the program also changes the freq. RX and vice versa.

To change the frequency place the mouse on the cell of the address you want to change (TX or RX) and click once (figure 1).

Wait for the control window to open (figure 2) and enter a value between 0 and 249 and click OK (figure 3).

In this phase the new value set on the TX Freq and RX Freq cells will be displayed.

To save the modification, click with the mouse on the red cell of the address you are configuring (figure 4).

ID	TX Freq
0	0
1	15
2	35

Figure 1

Frequency

Limits are 0..249

OK Cancel

Figure 2

Frequency

Limits are 0..249

OK Cancel

Figure 3

Read	Write	Real Time

Figure 4

TX LEVEL COLUMN

Displays the 4dB attenuation of the transmission signal for each address.

To activate or deactivate this parameter, position the mouse on the TX Level cell that you want to modify and click once (figure 1). Wait for the activation of the curtain control (figure 2), click a second time and select one of the two values 0 db or + 4db (figure 3).

With the value 0 db the signal is attenuated by 4 dB.

To save the modification, click with the mouse on the red cell of the address you are configuring (figure 4).

ID	TX Freq	Tx Level
0	0	0db
1	15	0db
2	35	0db

Figure 1

ID	TX Freq	Tx Level
0	0	0db
1	15	0db
2	35	0db

Figure 2

ID	TX Freq	Tx Level
0	0	0db
1	15	+4db
2	35	0db

Figure 3

Read	Write	Real Time

Figure 4

TX AND RX COLUMN LEDS ENABLED

They show the status of the green and red led on the TX and RX antennas.

To change the on / off condition, place the mouse on the led box whose status you want to change (figure 1) and click once (figure 2).

The flag in the box indicates the led are lit.

To save the modification, click with the mouse on the red cell of the address you are configuring (figure 4).



Figure 1

Figure 2

Figure 3

RX LEVEL COLUMN

Displays the level of the RX signal.

The values entered in this column cannot be changed.

INTRUDER SPEED COLUMN

Displays the time (in mS) of the duration of the attenuation of the alarm signal.

To change this parameter, place the mouse on the cell of the address you want to modify and click once (figure 1).

Wait for the control window to open (figure 2) and enter a value between 20 and 350, then click OK (figure 3).

To save the modification, click with the mouse on the red cell of the address you are configuring (figure 4).

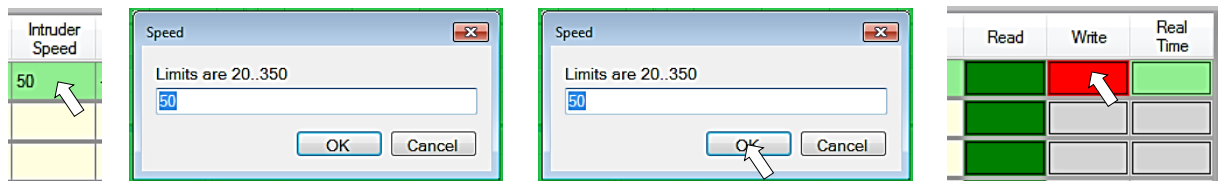

Figure 1

Figure 2

Figure 3

Figure 4

COLUMN ALARM OFFSET

Displays the level (in dB) of attenuation of the alarm signal.

To change this parameter, place the mouse on the cell of the address you wish to modify and click once (figure 1). Wait for the control window to open (figure 2) and enter a value between -20 and -1, then click OK (figure 3).

To save the modification, click with the mouse on the red cell of the address you are configuring (figure 4).

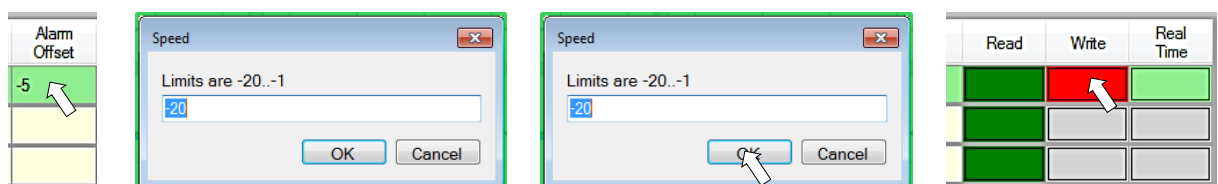

Figure 1

Figure 2

Figure 3

Figure 4

ALARM LEVEL COLUMN

Displays the level of the alarm signal.

The values entered in this column cannot be changed.

COLUMN ALARM DISABLED

Displays the status of the alarm output (ALARM terminal RX output).

To change the activation or deactivation condition, position the mouse on the panel of the output whose status you want to change (figure 1), then click once (figure 2).

The flag in the box indicates that the output is not active (figure 2).

To save the modification, click with the mouse on the red cell of the address you are configuring (figure 4).

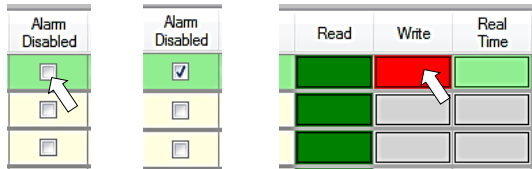

Figure 1

Figure 2

Figure 3

MODE COLUMN

Displays the default detection mode.

This parameter cannot be changed.

READ – WRITE – REAL TIME COLUMNS

READ COLUMN

Reading / enabling column for changes.

Instructions: click with the mouse on the green box of the address you want to read / modify.

WRITE COLUMN

Column for writing / editing parameters.

Instructions: Once the changes have been made to an address, click on the corresponding red box with the mouse.

REAL TIME COLUMN

Activation of the real-time display panel of the signal level for each pair of antennas. Function to be used during the installation phase to verify, according to the parameters assigned, the signal level.

IMPORTANT: once the display panel is activated, the configuration table is automatically inhibited and parameters can no longer be changed. To reactivate the commands, click on the Pause button.

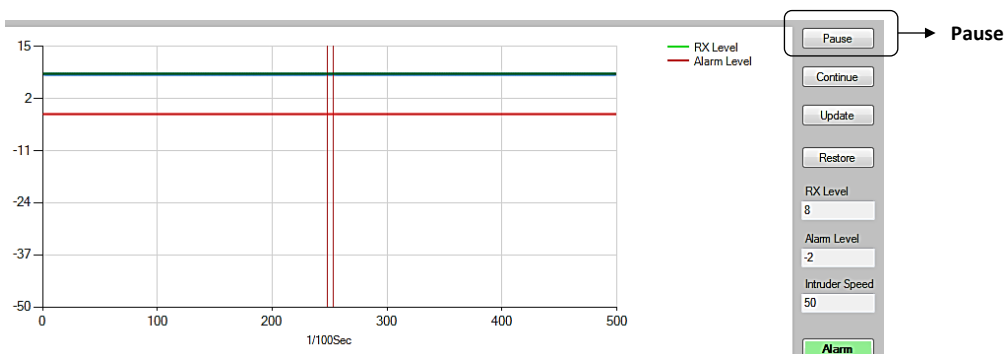

Connection options - RS485-USB adapter

Option 1

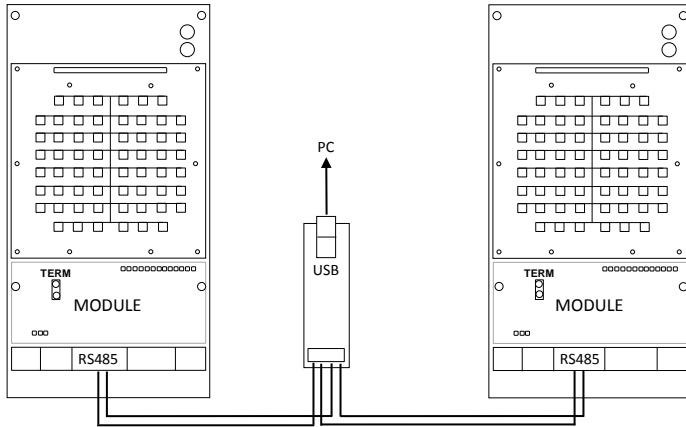

IMPORTANT

In the first and last modules connected, insert the TERM jumper

Option 2

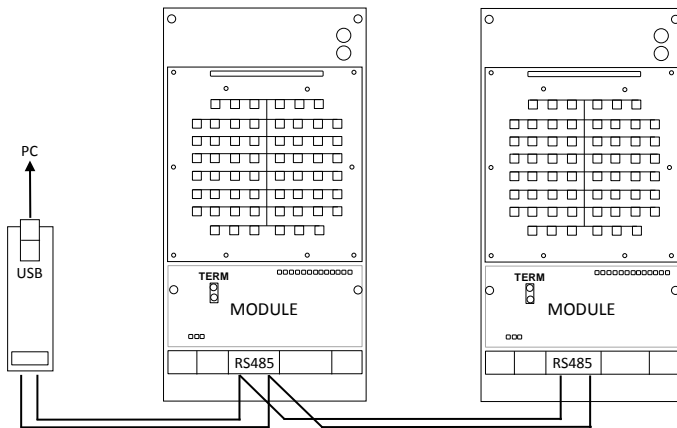

IMPORTANT

Using an adapter with 120 Ohm fixed termination (measurable value between pins A - B) insert the TERM jumper in the last connected module.

Using a terminated adapter selectable set the value of 120 Ohm and insert the TERM jumper in the last connected module.

Using an adapter without termination, insert a resistor from 120 Ohm between pins A - B and insert the TERM jumper in the last connected module.

IMPORTANT

For all connections it is necessary to respect the following connection diagram:

A with A - B with B

Warnings

1. When preparing the device and during its use, observe the current technical safety standards for electrical installations.
2. For standard installations recommended by the manufacturer with antennas positioned at 80/90 cm from the ground, the maximum height of the snowpack or grass must not exceed the limit of 30 cm beyond which the device may not report any movement / intrusion to its indoor.
3. Avoid creating interference due to incorrect pointing of multiple TX antennas towards the same RX antenna.
4. Use shielded cables.
5. Supply the device with a stabilized voltage of 13.8 Vdc.
6. Installation must be carried out by qualified personnel.
7. MITECH is not responsible for damages and / or malfunctions of the barriers caused by incorrect installation and / or improper use of the same.

Product photos





MITECH® srl

Offices:
Via Roncaglia, 14
20146 Milano – Italia

Production:
Via Ramazzone, 23
43010 Fontevivo (PR) – Italia

Phone: +39 02.48006383
Fax: +39 02.48025620
tech@mitech-security.com



www.mitech-security.com

MADE IN ITALY

MICRO 8 - Rev. 04 – 09/2020 - MITECH® srl reserves the right to change the information in this document without warning.